

## Linea QUADRO

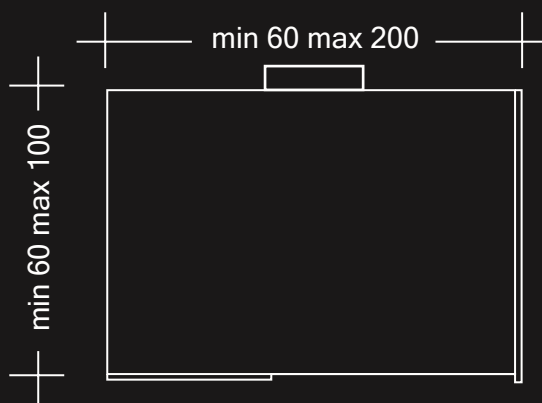

ANGOLO

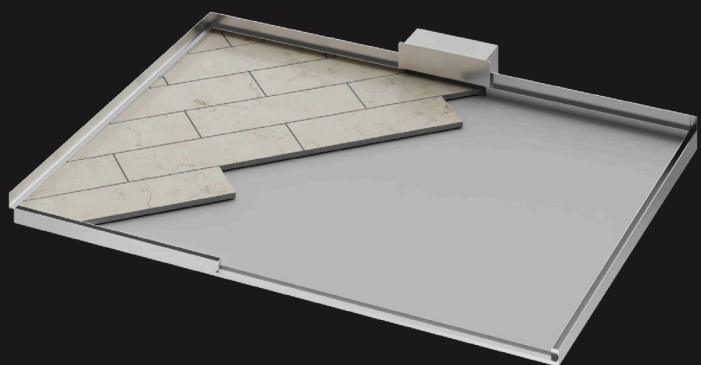

ANGOLO + SP



NICCHIA



NICCHIA + SP

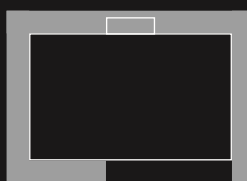

PARETE



SMANCO COLONNA



## Linea PENTA

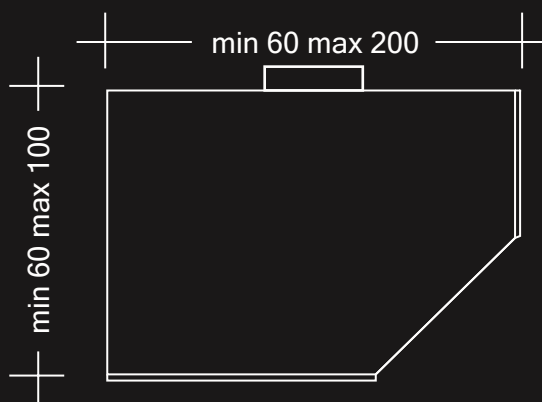
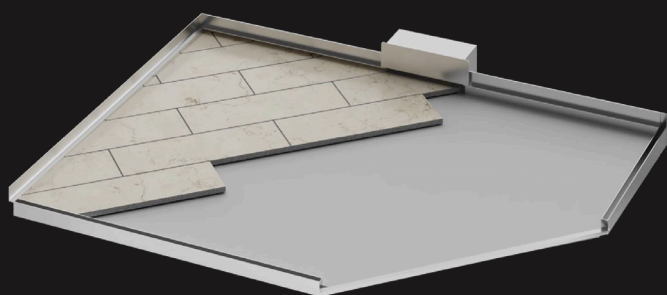

ANGOLO

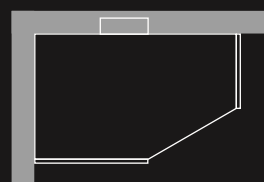

NICCHIA

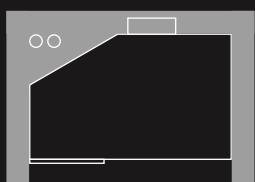

NICCHIA + SP

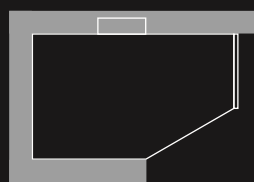

PARETE

