

Linea QUADRO

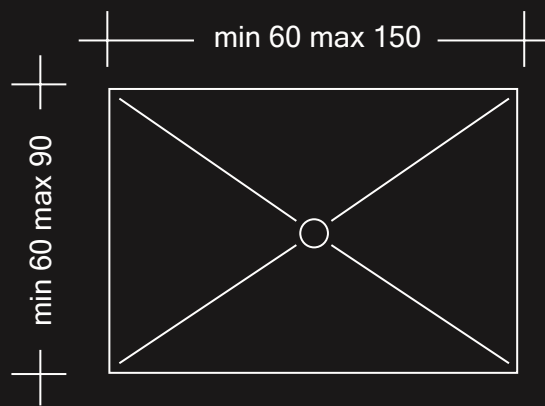

ANGOLO

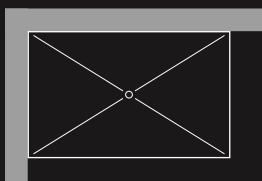

ANGOLO + SP

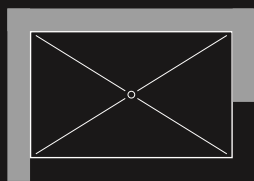

NICCHIA

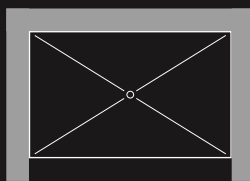

NICCHIA + SP

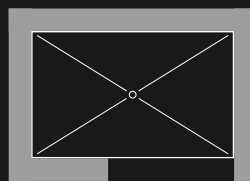

PARETE

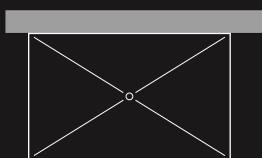

DOPPIA PARETE

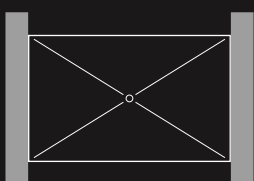

SMANCO COLONNA

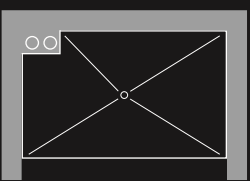

FUORI SQUADRO

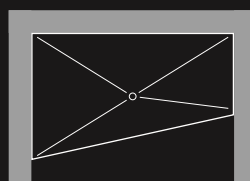

Linea PENTA

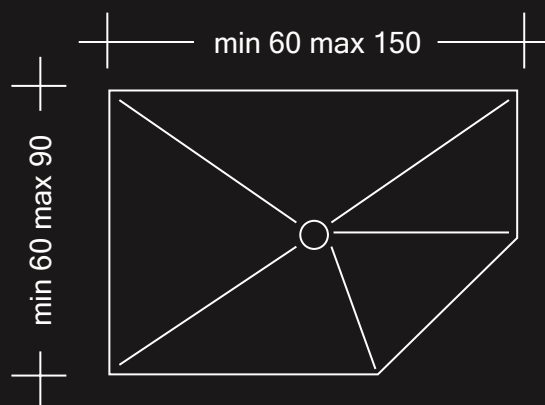
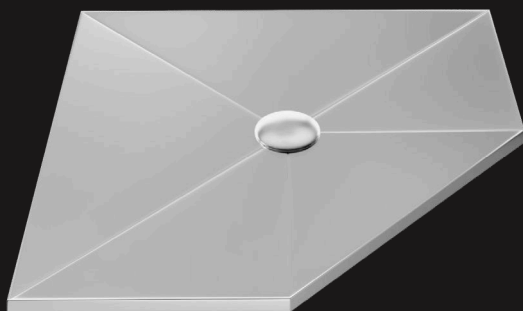

ANGOLO

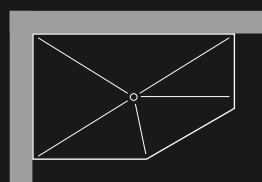

NICCHIA

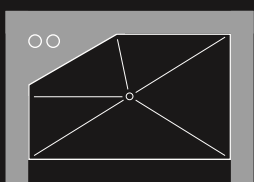

NICCHIA + SP

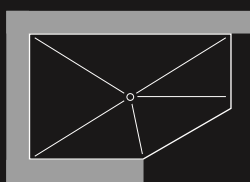

PARETE

